

eve aqua 



Sala:.....

Notas:.....



eve aqua 

Como começar

Como começar

1

Coloque as pilhas AA incluídas antes de iniciar a instalação.

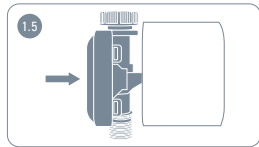
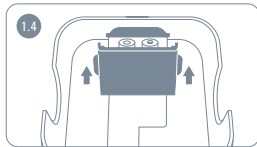
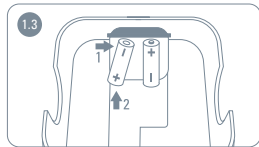
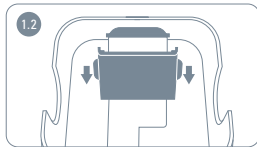
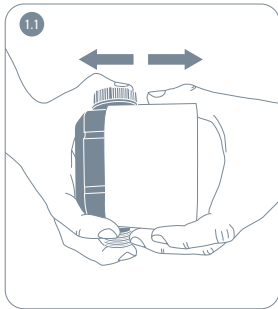

Como começar

②

Ligue o Eve Aqua à torneira e coloque uma mangueira na outra extremidade.

i

Atenção: garanta que o Eve Aqua não fica exposto ao gelo.

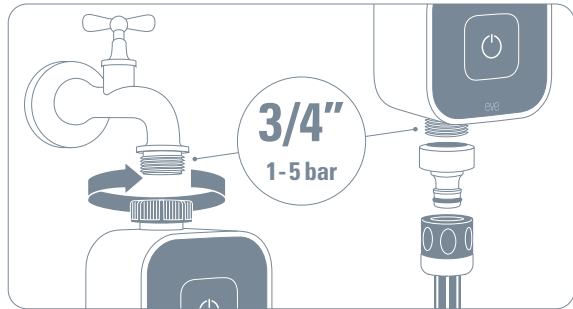

Como começar

3

Faça download da app Eve na App Store.

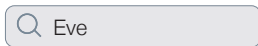

Como começar

④

Abra a aplicação Eve e adicione o acessório.
A aplicação dará indicações de como o configurar.

Add Accessory

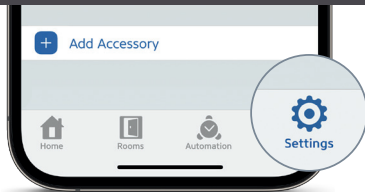

Se já tem mais acessórios configurados na aplicação,
vá a Settings e adicione o Eve Aqua.

Aproveite

5 Controle o Eve Aqua com a aplicação Eve, Home app e Siri.



Controlar

Activar bloqueio infantil

Instalar atualizações de firmware

Configure horários

Monitorar consumo de água



Controlar

Configurar acesso a convidados



Controlar

6 Também poderá carregar no botão para começar ou parar a rega.

i Eve Aqua irá desligar-se automaticamente quando a duração por defeito, configurada na App Eve, terminar.

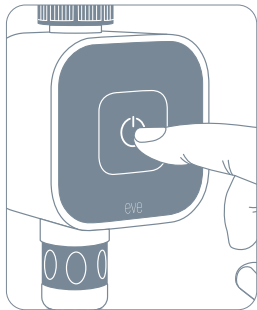

Aproveite

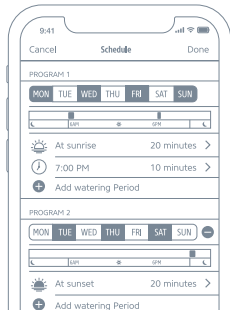

Os horários controlam a Eve Aqua automaticamente, independentemente do iPhone ou home hub. Configure horários para regar automaticamente a horários específicos através da App Eve.



Eve é concebida para proteger os seus dados pessoais. Todos os dados são completamente encriptados e transferidos directamente apenas entre o seu Eve Aqua e iPhone, iPad ou home hub. Saiba mais em evehome.com/privacy.

Reinicializar

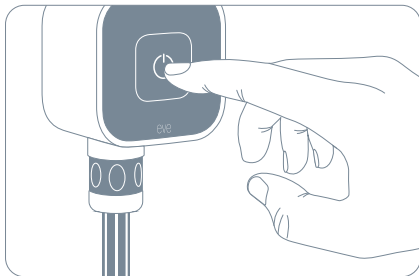
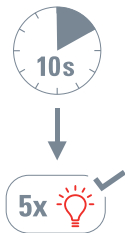

Mantenha o seu código de Setup HomeKit num lugar seguro. Precisar\'a dele para adicionar Eve \u00e0 sua casa e e mais ningu\u00e9m al\u00e9m de si o conhece ou tem uma c\u00f3pia.

Product: 10ECC8101 • Model: 20ECC8101 • Part: 51ECC9901

Powered by

